



Gebruiksaanwijzing Mestic app **NL** User instructions Mestic app **EN**

SMART ADVENTURE

**Dakairconditioner
RTA-2500L wit / zwart**

NEDERLANDS

Download en installeer de Mestic app

1. Download de gratis Mestic app via de App Store van Apple of de Play Store van Google. Of scan de QR-code hieronder.

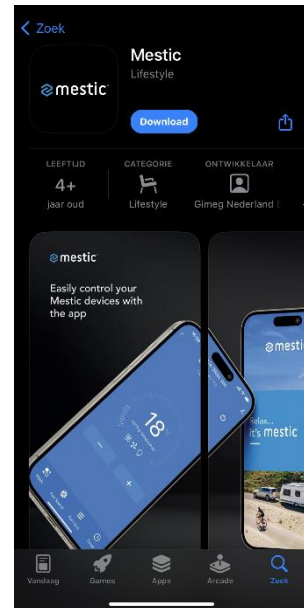
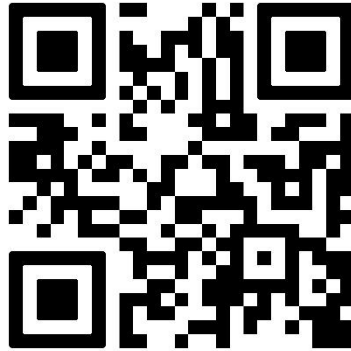

Registreren en inloggen

2. Open de Mestic app en lees de gebruikersovereenkomst en het privacy beleid zorgvuldig door en klik bij akkoord op 'Akkoord'.
3. Heb je geen account? Selecteer nieuw account en maak een account aan. Selecteer vervolgens jouw land en voer een geldig e-mailadres in om de verificatiecode te kunnen ontvangen. Lees de 'registratie met eens privacy beleid en service-overeenkomst' goed door en vink deze aan.
4. Voer jouw emailadres in en druk op 'Verificatiecode ophalen'.
5. In je mail ontvang je de verificatiecode en voer deze in de app in. Kies een wachtwoord met een mix van letters en cijfers en klik op 'doorgaan'. Sta de volgende meldingen toe; 'Mestic wil apparaten op je lokale netwerk zoeken en er verbinding mee maken', 'service en onderhoud' en 'gepersonaliseerde aanbevelingen'. Klik op 'go to app'.
6. Sta de melding toe: 'bluetooth'. Deze functies zijn nodig voor het goed kunnen functioneren van de app.

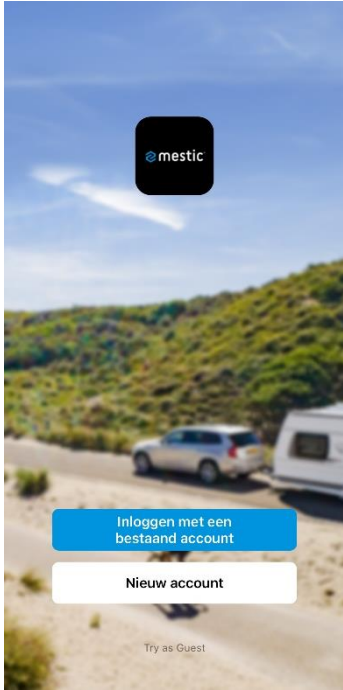

1

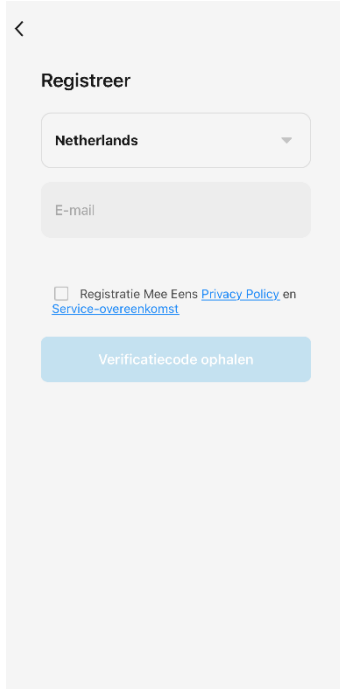

2

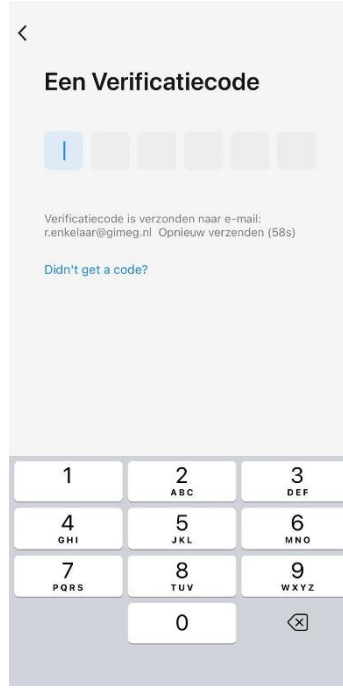

3

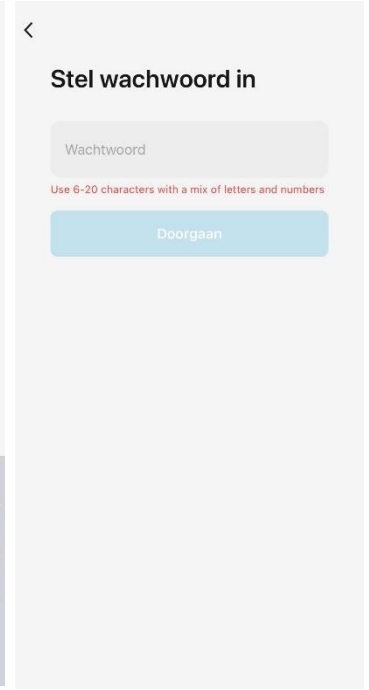

4

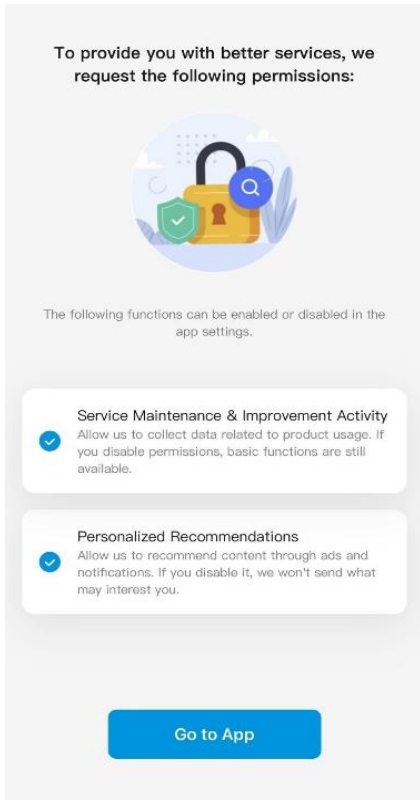

5

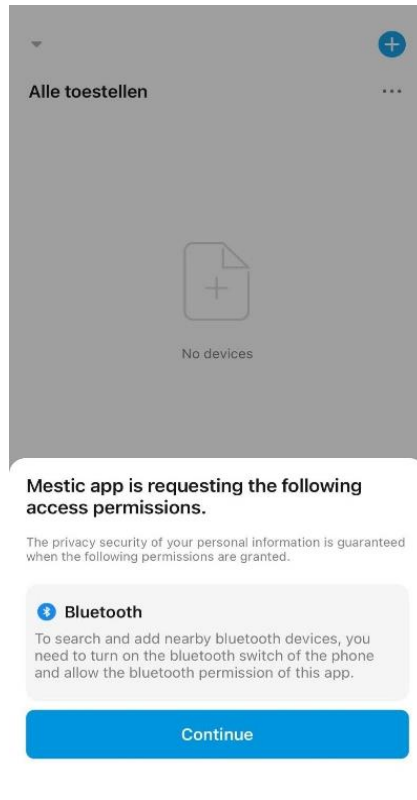

6

Het apparaat toevoegen in de Mestic app met WiFi of Bluetooth

7. Open de Mestic app. Zorg dat de Bluetooth of WiFi en locatie van je telefoon aan, zodat de app kan zoeken naar een apparaat in de buurt. Zet de dakairconditioner aan.
8. Druk op de blauwe + teken rechtsboven en 'add device' om een toestel toe te voegen. De Mestic app vindt automatisch het apparaat.
9. Een andere manier om een toestel toe te voegen is: druk in het midden op de blauwe knop 'toestel toevoegen'. De Mestic app vindt het apparaat automatisch. Wanneer de verbinding met de Bluetooth of WiFi is voltooid, gaat de Bluetooth of WiFi knop aan. Voltooi de verbinding binnen 5 minuten. Als het apparaat niet binnen de eerste 5 minuten is verbonden, is de Bluetooth of WiFi knop uit. Als je opnieuw verbinding wilt maken met de Mestic app, zet het apparaat dan uit en weer aan. Dan heb je nog eens 5 minuten om verbinding te maken met de Mestic app.
10. De app vraagt toegang tot je locatie en Bluetooth om een apparaat in de buurt te vinden. Met de home data kun je de app eventueel koppelen met een smarthome oplossing, bijvoorbeeld Google Home. Druk vervolgens op 'continue'.
11. Klik vervolgens het juiste apparaat aan en voeg deze toe.

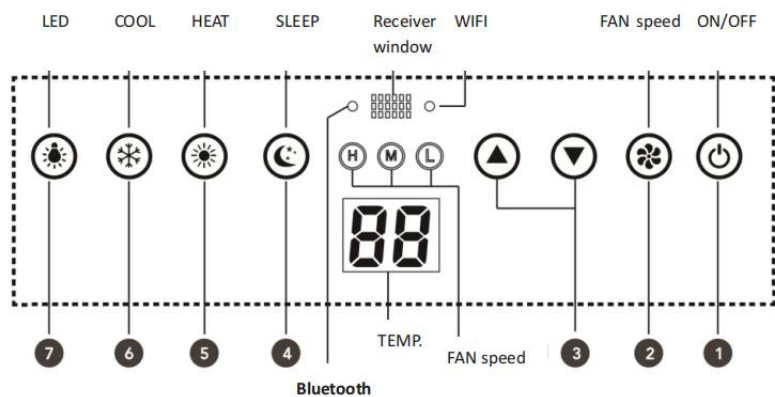

7

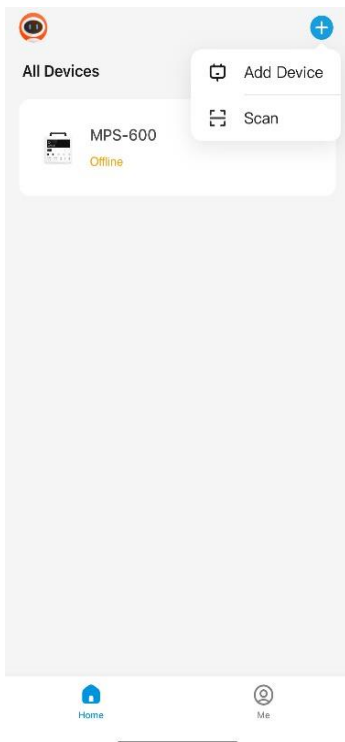

8

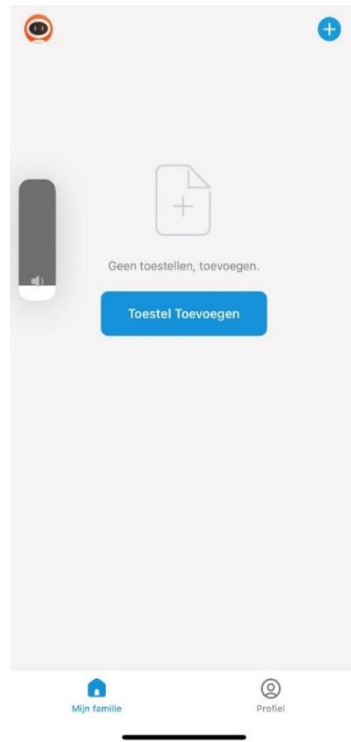

9

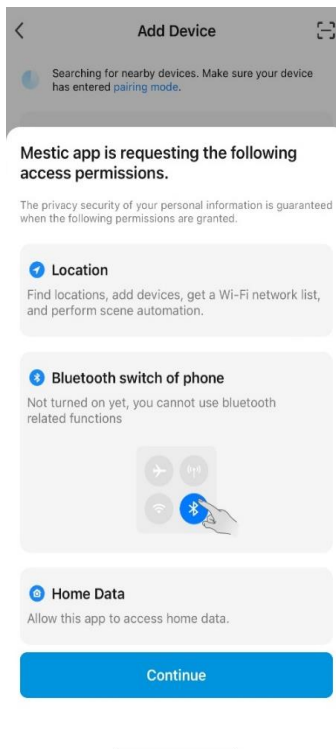

10

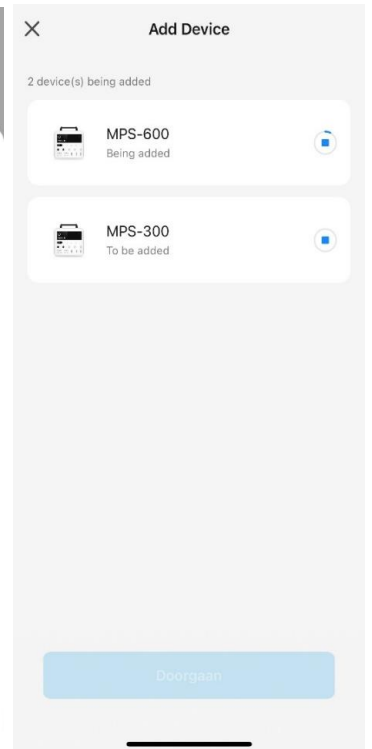

11

Bluetooth-verbinding resetten

Wanneer het apparaat in stand-by staat (met de stroom aan, maar het apparaat niet activeert).

- Als de Bluetooth knop langzaam knippert, druk dan 3 sec op de "COOL" knop, totdat je een 'piep' hoort en de Bluetooth is gereset.
- Als de Bluetooth knop snel knippert (3x per seconde), zal de Mestic app het apparaat automatisch vinden, klik op "Verbinden".

WiFi-verbinding resetten

Wanneer het apparaat in stand-by staat (met de stroom aan, maar activeer het apparaat niet).

- Houd de knop "FAN SPEED" 3 sec ingedrukt, totdat je een 'piep' hoort.
- De WiFi verbinding is nu gereset en de knop knippert snel (3x per seconde.) De Mestic app zal het apparaat automatisch vinden, klik op "Verbinden".

Opmerkingen

- Wanneer er geen WIFI-verbinding is, knippert de WiFi knop langzaam gedurende 10 sec (om aan te geven dat het netwerk wordt gezocht.)

Mestic app uitleg

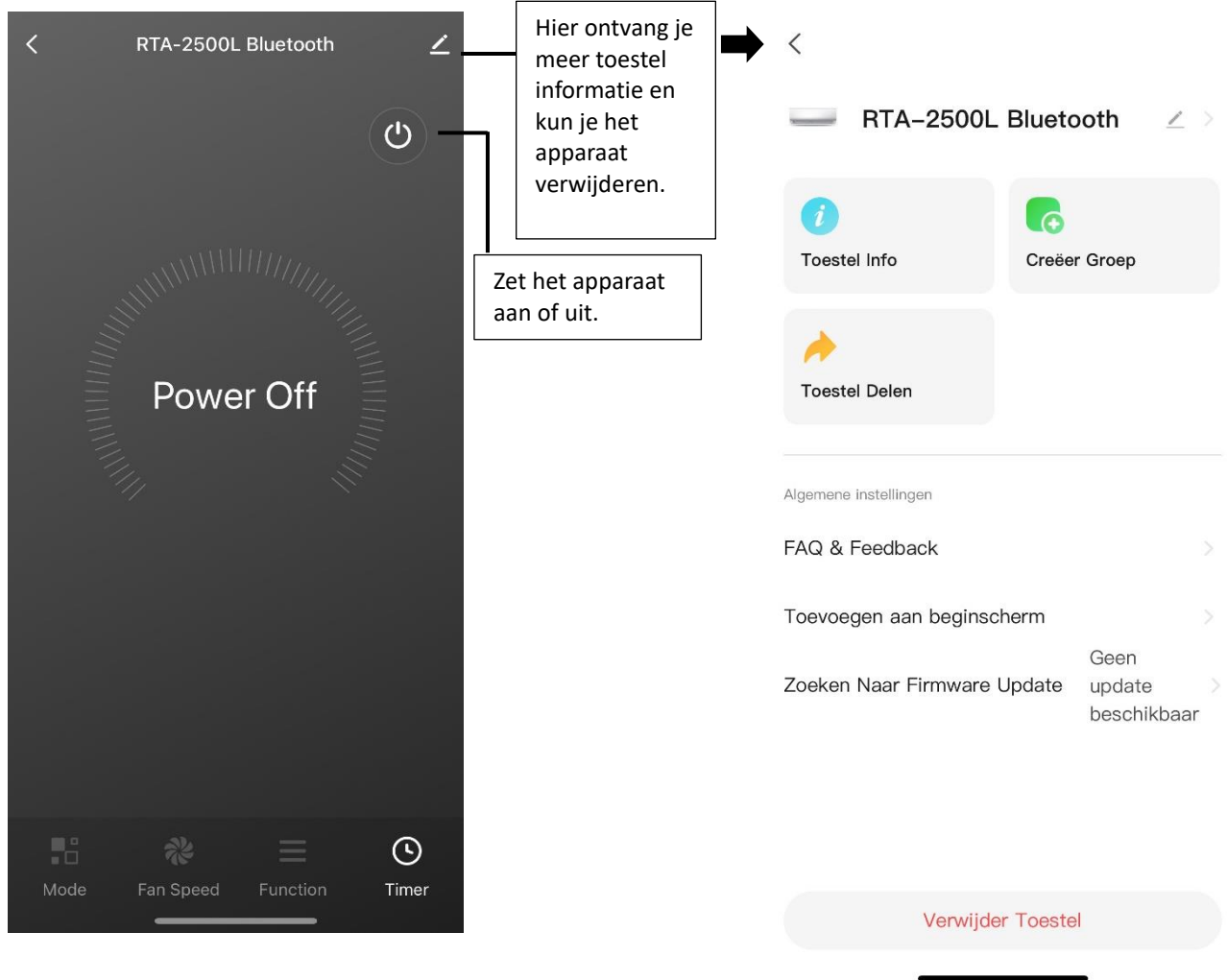

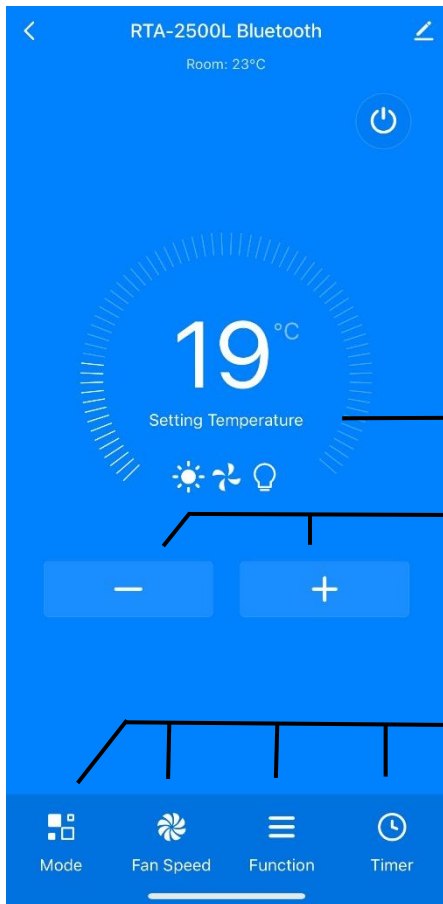

Ruimte temperatuur

Ingestelde temperatuur

Zet de temperatuur lager met de - en hoger met de +.

Gebruik de verschillende functies onderaan om de airco in te stellen.
Mode: modus
Fan Speed: ventilator stand
Function: functies
Timer: tijd

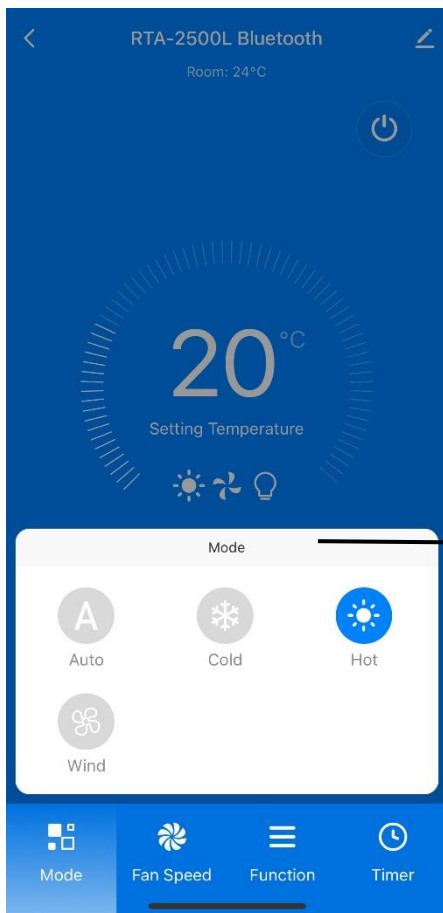

Mode in te stellen in: automatisch, koelen, verwarmen of ventilatorstand.

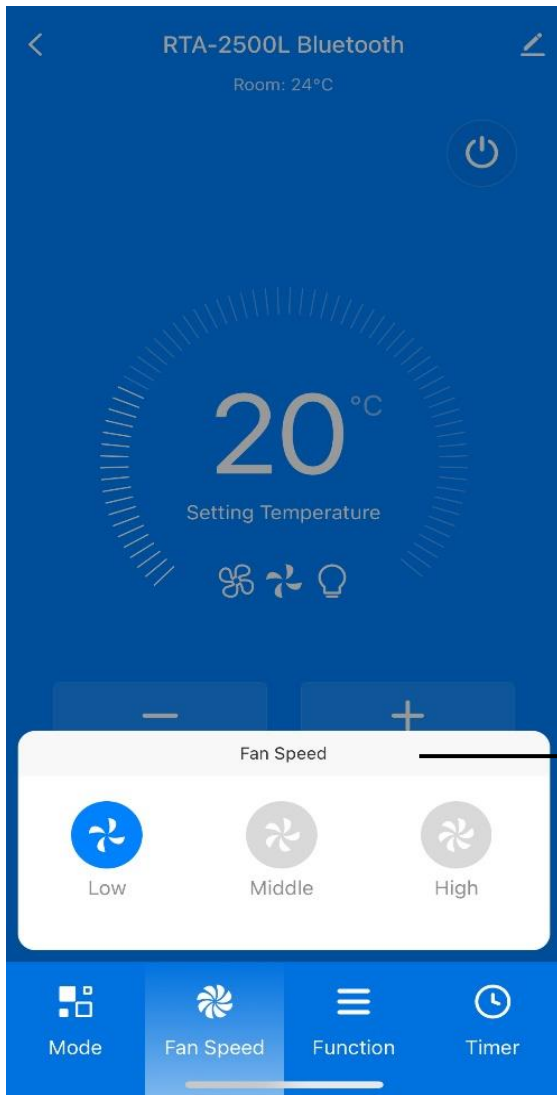

Fan Speed: Ventilatorstand in te stellen in: laag, middel en hoog.

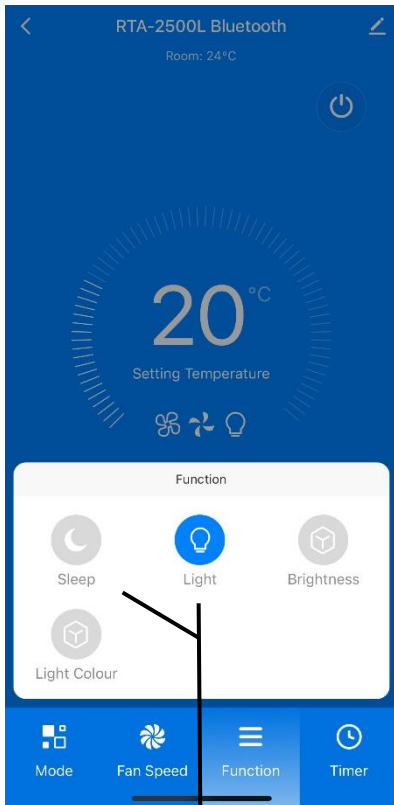

Sleep: stilste modus, zonder verlichting
Light: aan- en uitzetten van de lamp.

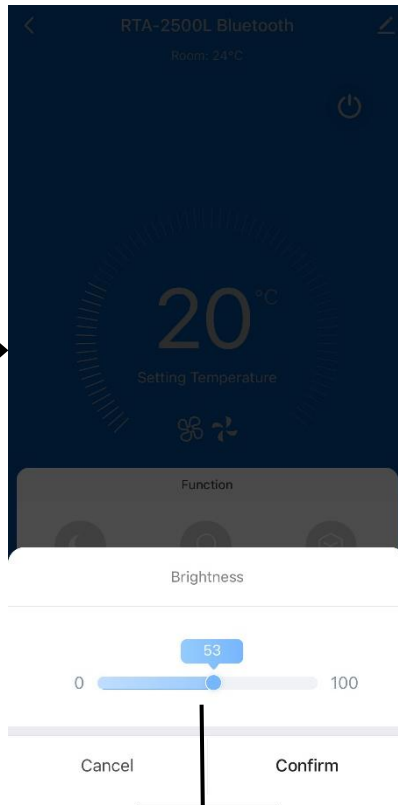

Brightness: de helderheid van de lamp kun je aanpassen van 0 tot 100, waarbij 100 het meest fel is.

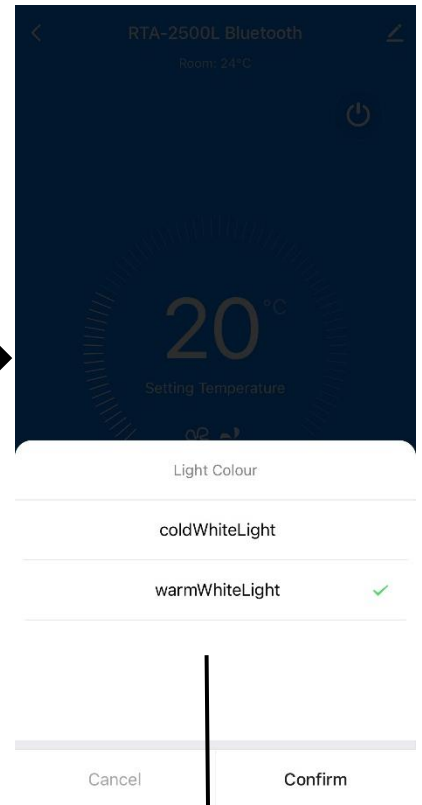

Light colour: het licht van de lamp kun je aanpassen naar warm of koud wit licht.

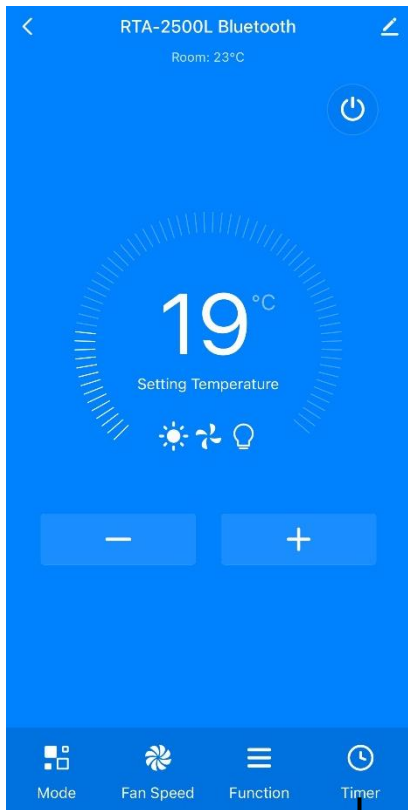

Timer: Stel de airco op een gewenste tijd en dag in en je kampeervoertuig is de gewenste temperatuur als je terugkomt.

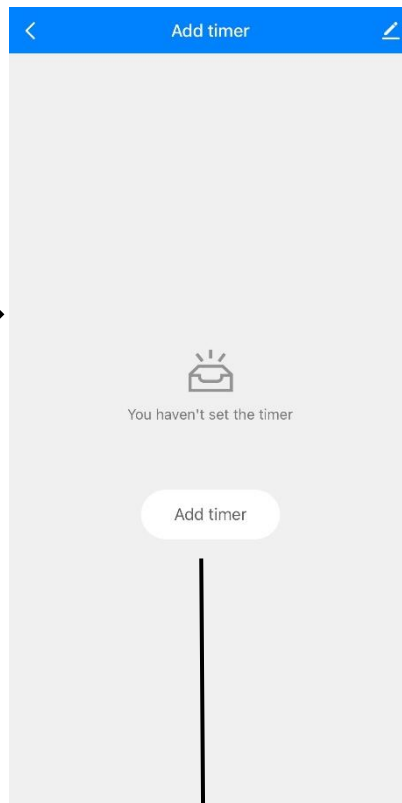

Druk op 'add timer' om een timer te zetten.

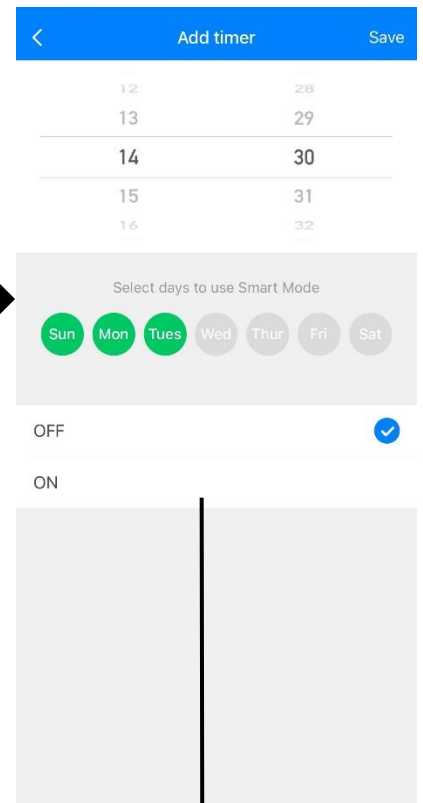

Stel de tijd in en selecteer de gewenste dag. Druk op 'on' en 'save', zodat de instellingen worden opgeslagen.

ENGLISH

Download and install the Mestic app

1. Download the free Mestic app from Apple's App Store or Google's Play Store. Or scan the QR code below.

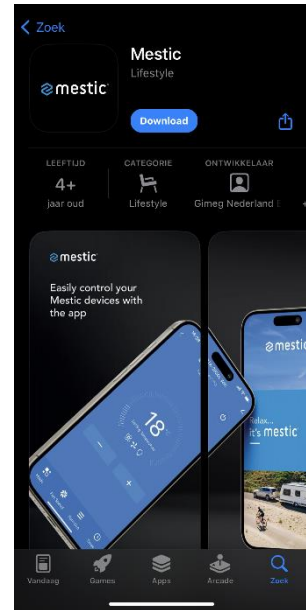

Register and login

2. Open the Mestic app and carefully read the user agreement and privacy policy and when you agree, click 'Agree'.
3. Don't have an account? Select new account and create an account. Then select your country and enter a valid email address to receive the verification code. Carefully read and check the 'registration agree privacy policy and service agreement'.
4. Enter your email address and press 'Get verification code'.
5. In your email you will receive the verification code and enter it in the app. Choose a password with a mix of letters and numbers and click 'continue'. Allow the following notifications; 'Mestic wants to search and connect devices on your local network', 'service and maintenance' and 'personalized recommendations'. Click 'go to app'.
6. Allow the notification: 'bluetooth'. These functions are necessary for the app to function properly.

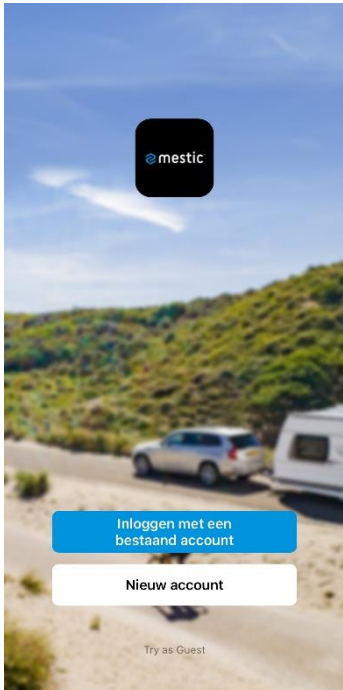

1

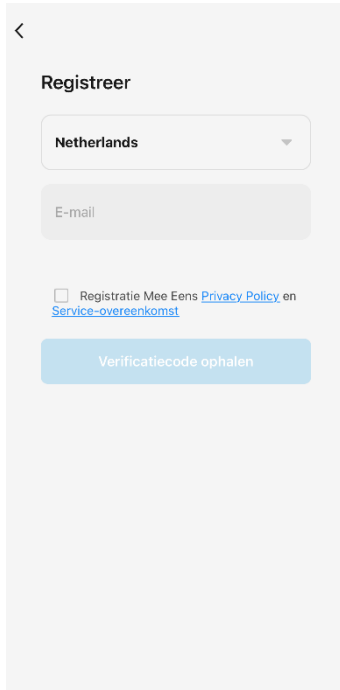

2

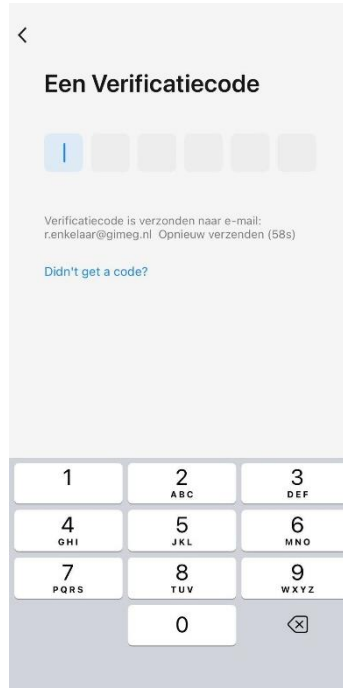

3

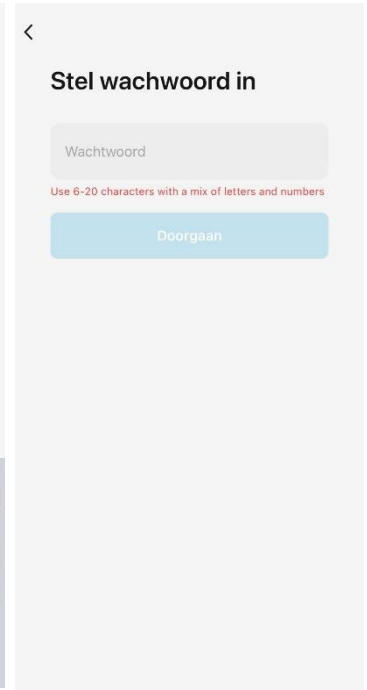

4

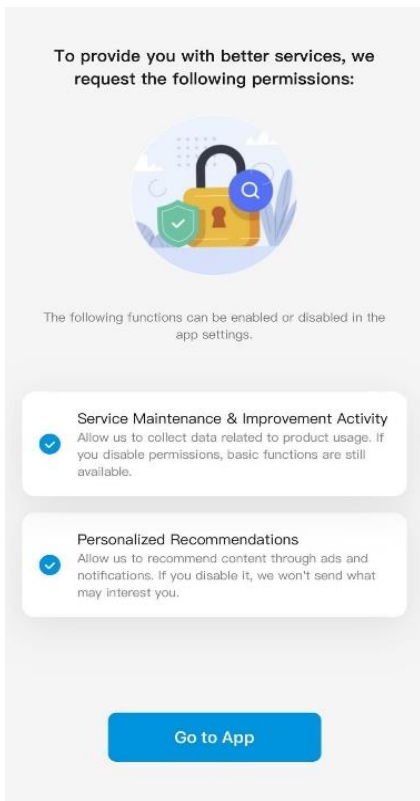

5

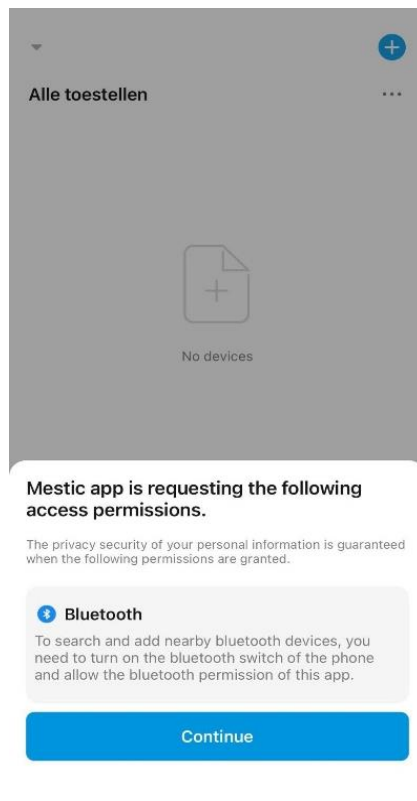

6

Add the device in the Mestic app with WiFi or Bluetooth

7. Open the Mestic app. Make sure your phone's Bluetooth or WiFi and location are on so the app can search for a nearby device. Turn on the rooftop air conditioner.
8. Press the blue + sign at the top right and "add device" to add a device. The Mestic app will automatically find the device.
9. Another way to add a device is: press the blue 'add device' button in the middle. The Mestic app automatically finds the device. When the Bluetooth or WiFi connection is complete, the Bluetooth or WiFi button turns on. Complete the connection within 5 minutes. If the device is not connected within the first 5 minutes, the Bluetooth or WiFi button is off. If you want to reconnect to the Mestic app, turn the device off and on again. Then you have another 5 minutes to connect to the Mestic app.
10. The app requests access to your location and Bluetooth to find a nearby device. With the home data, you can possibly pair the app with a smarthome solution, for example Google Home. Then press continue.
11. Next, click the correct device and add it.

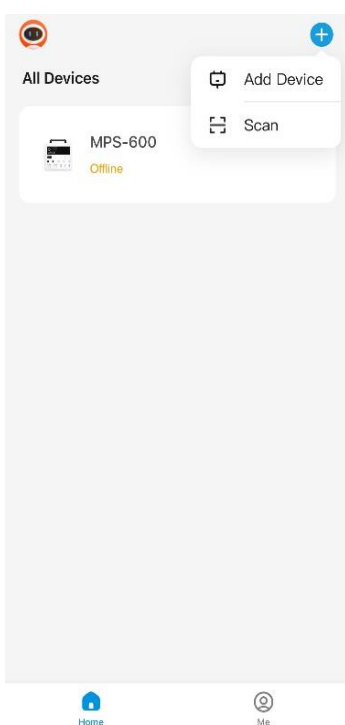
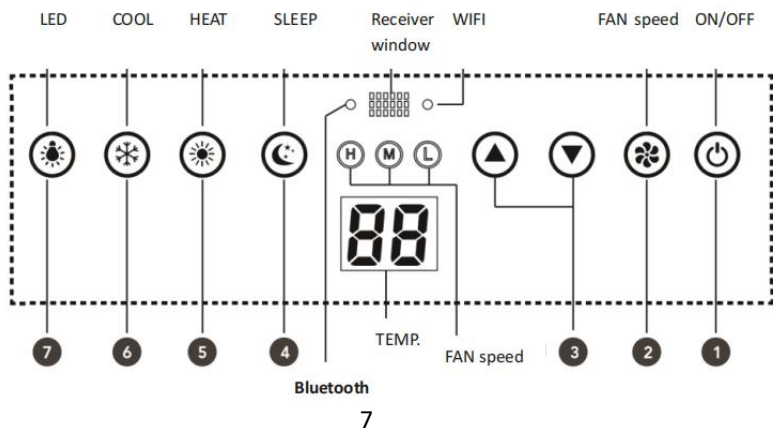

8

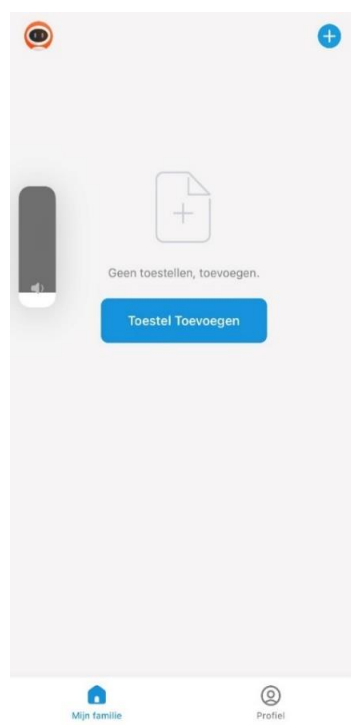

9

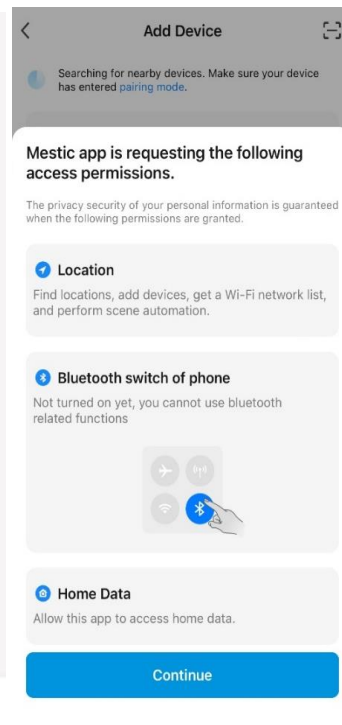

10

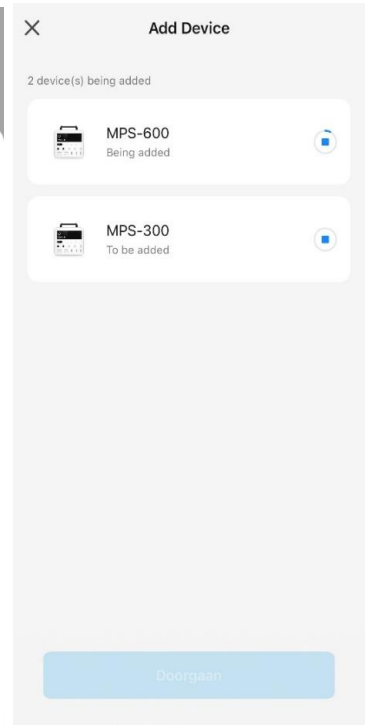

11

Resetting Bluetooth connection

When the device is in standby (with the power on, but not activating the device).

- If the Bluetooth button blinks slowly, press the "COOL" button for 3 sec, until you hear a "beep" and the Bluetooth is reset.
- If the Bluetooth button flashes quickly (3x per second), the Mestic app will automatically find the device, click "Connect".

Resetting WiFi connection

When the device is in standby mode (with the power on, but do not activate the device).

- Press and hold the "FAN SPEED" button for 3 sec, until you hear a "beep".
- The WiFi connection is now reset and the button flashes rapidly (3x per second.) The Mestic app will automatically find the device, click "Connect".

Notes

- When there is no WiFi connection, the WiFi button blinks slowly for 10 sec (to indicate that the network is being searched).

Mestic app explanation

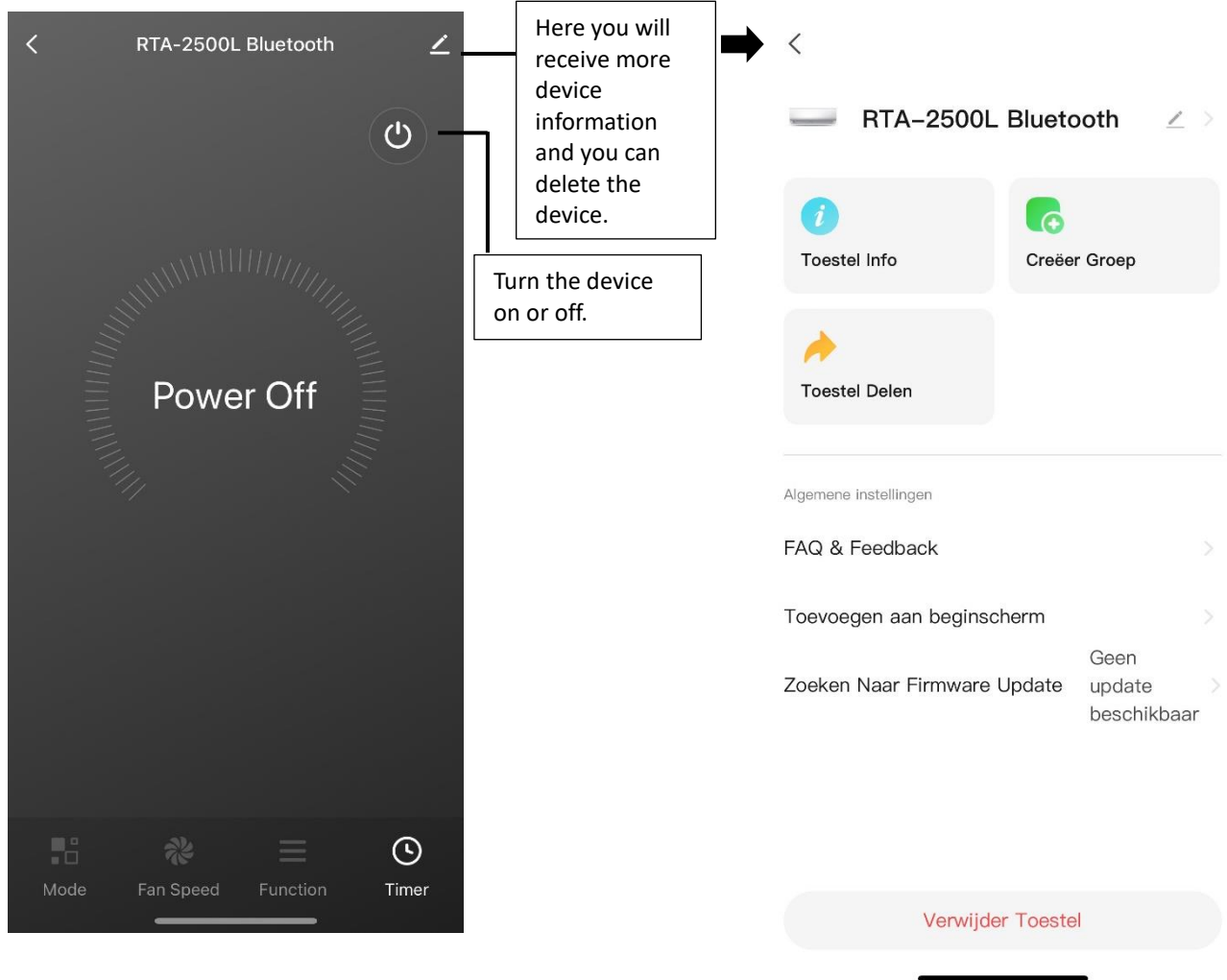

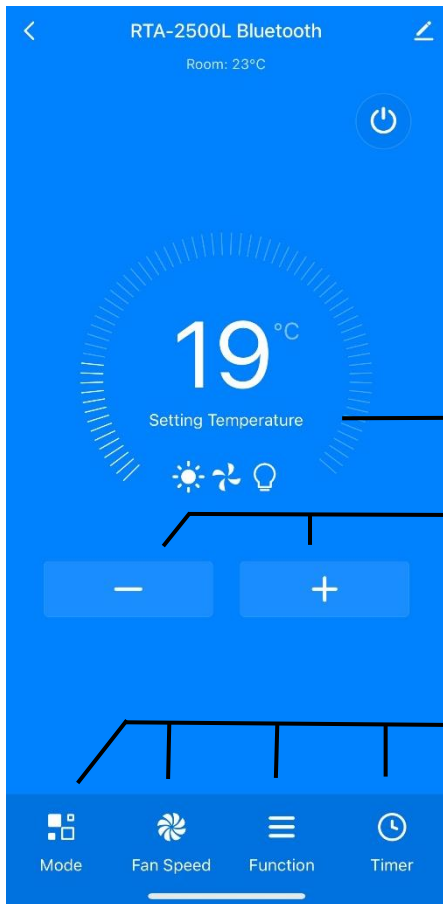

Room temperature

Set temperature

Set the temperature lower with the - and higher with the +

Use the different functions below to set the air conditioner. Mode, fan speed, function, timer

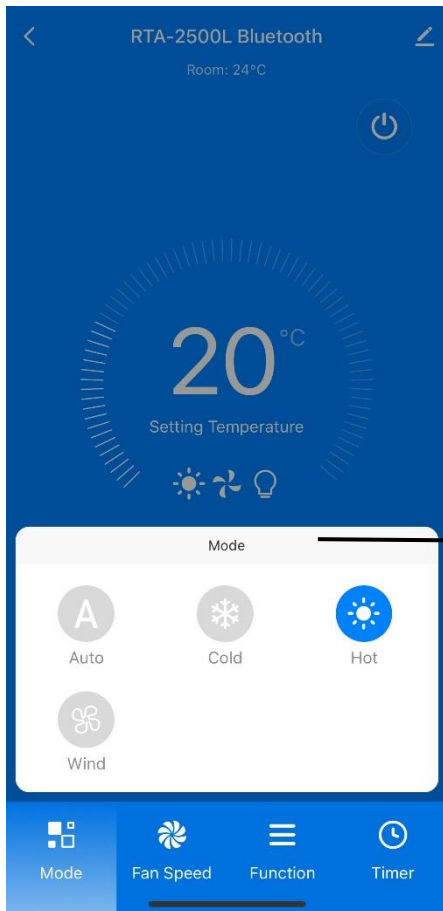

Mode set in: automatic, cooling, heating or fan mode

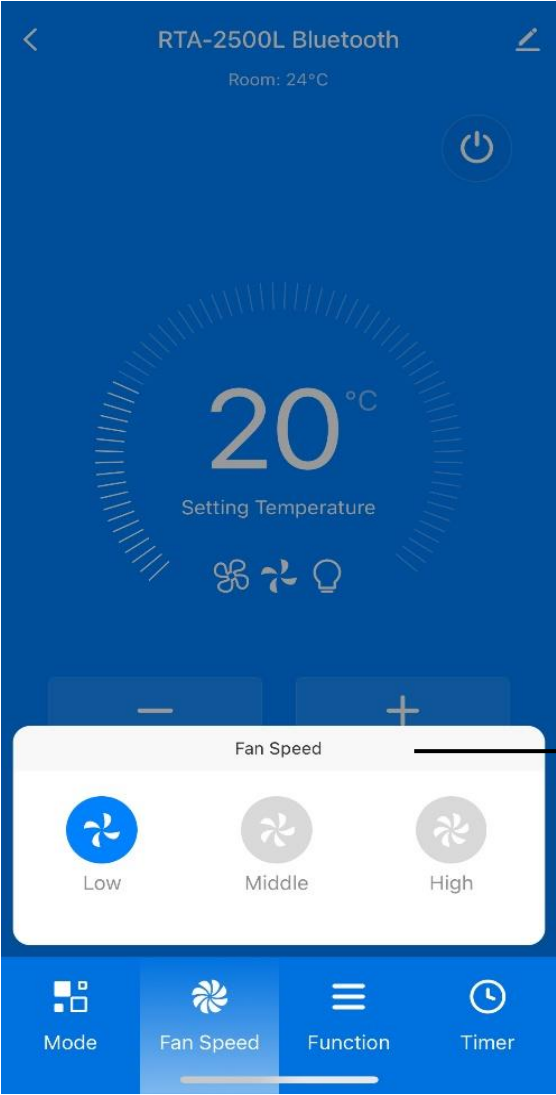

Fan speed can be set to: low, medium and high

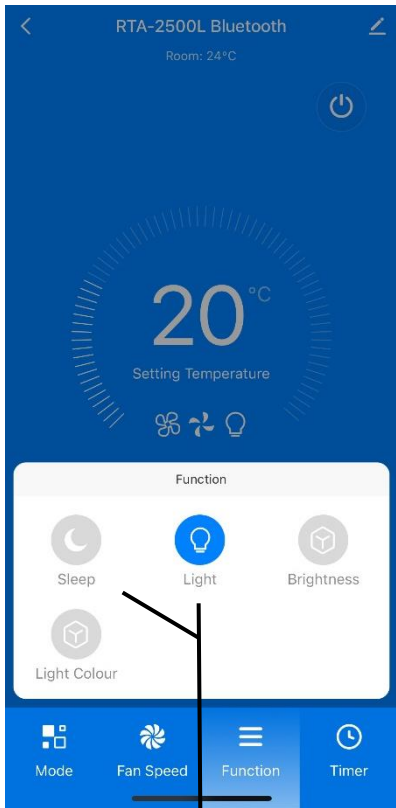

Sleep: quietest mode, without illumination
Light: turning the lamp on and off

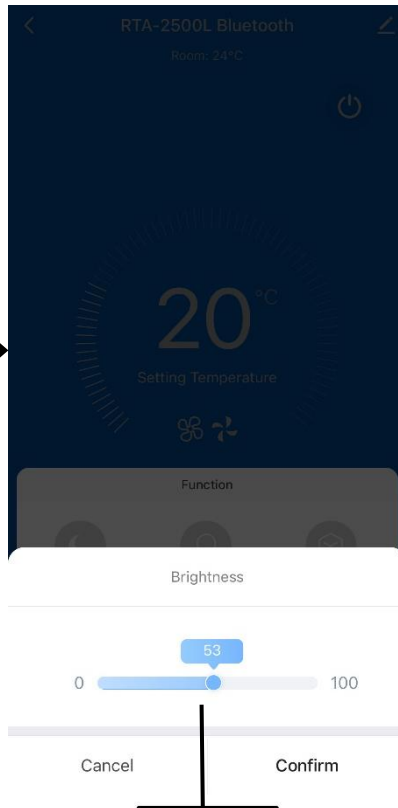

Brightness: the brightness of the lamp can be adjusted from 0 to 100, with 100 being the brightest

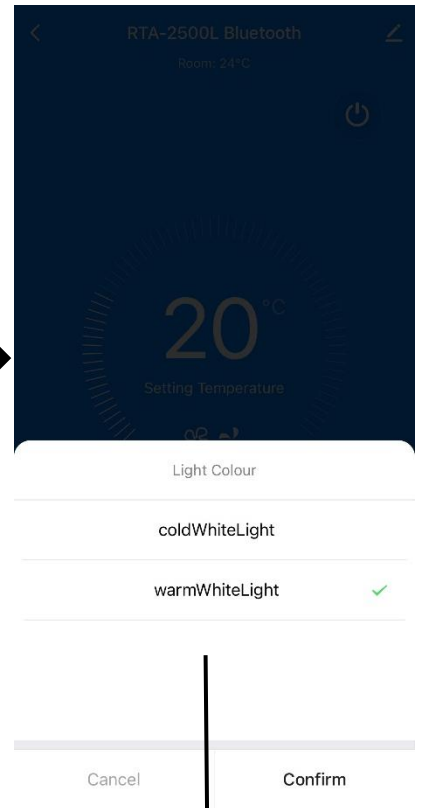

Light color: you can adjust the light of the lamp to warm or cold white light

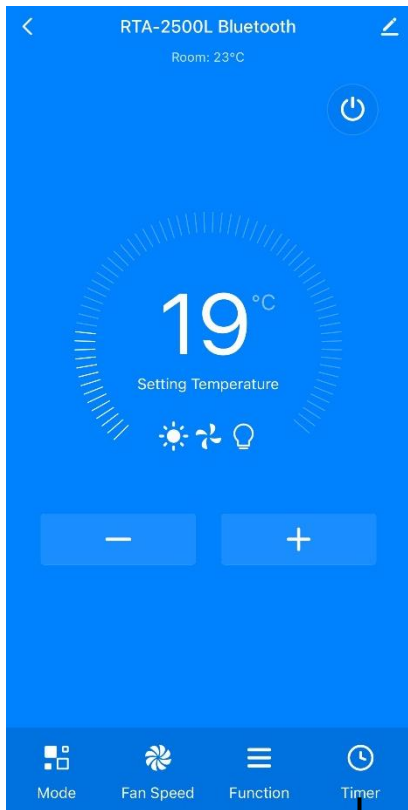

Timer: Set the air conditioner to a desired time and day and your camper will be the desired temperature when you return

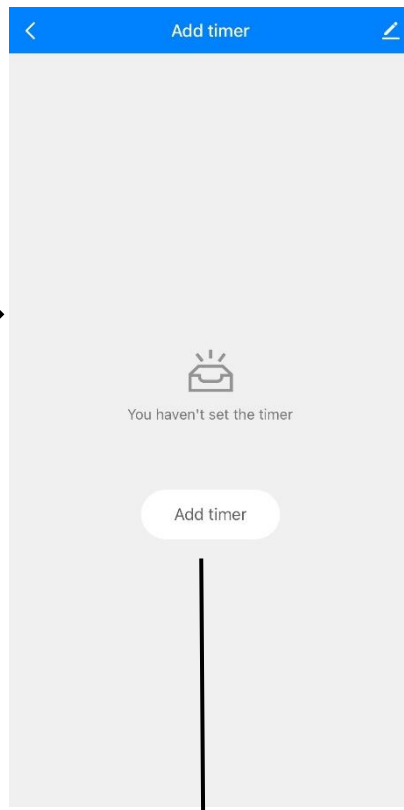

Press 'add timer' to set a timer

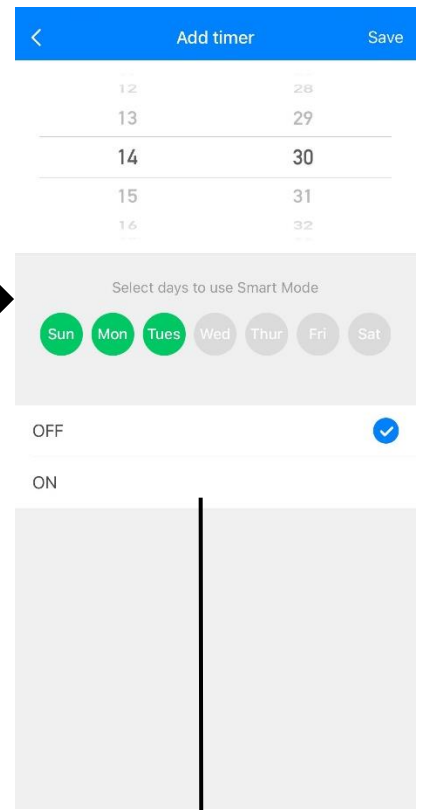

Set the time and select the desired day. Press 'on' and 'save' to save the settings

mestic[®]

Mestic is a brand of Trigano Accessory Group
Atoomweg 99, 3542 AA Utrecht
The Netherlands
Mestic.nl